

Julia G, Oliver, Ali, Carly, Jack

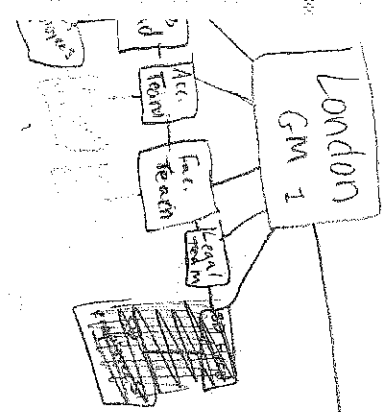

NYC GM 1

Orlando GM 1

Austin GM 1

LA GM 1

Seattle GM 1

Company 1  
President

5 Dept. Heads



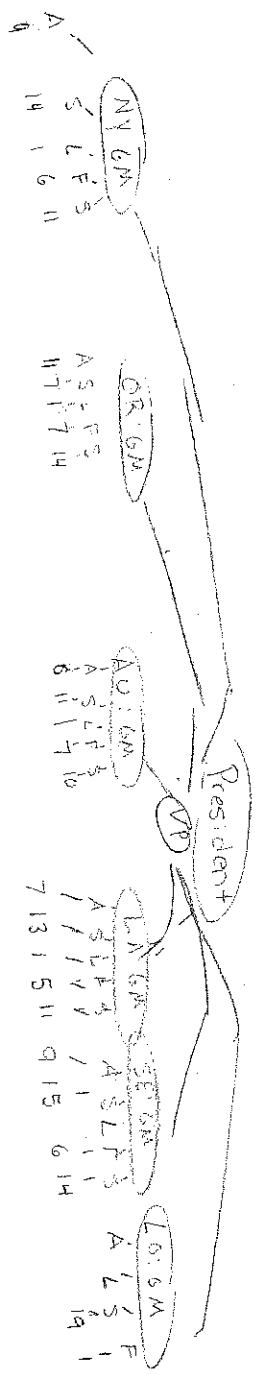

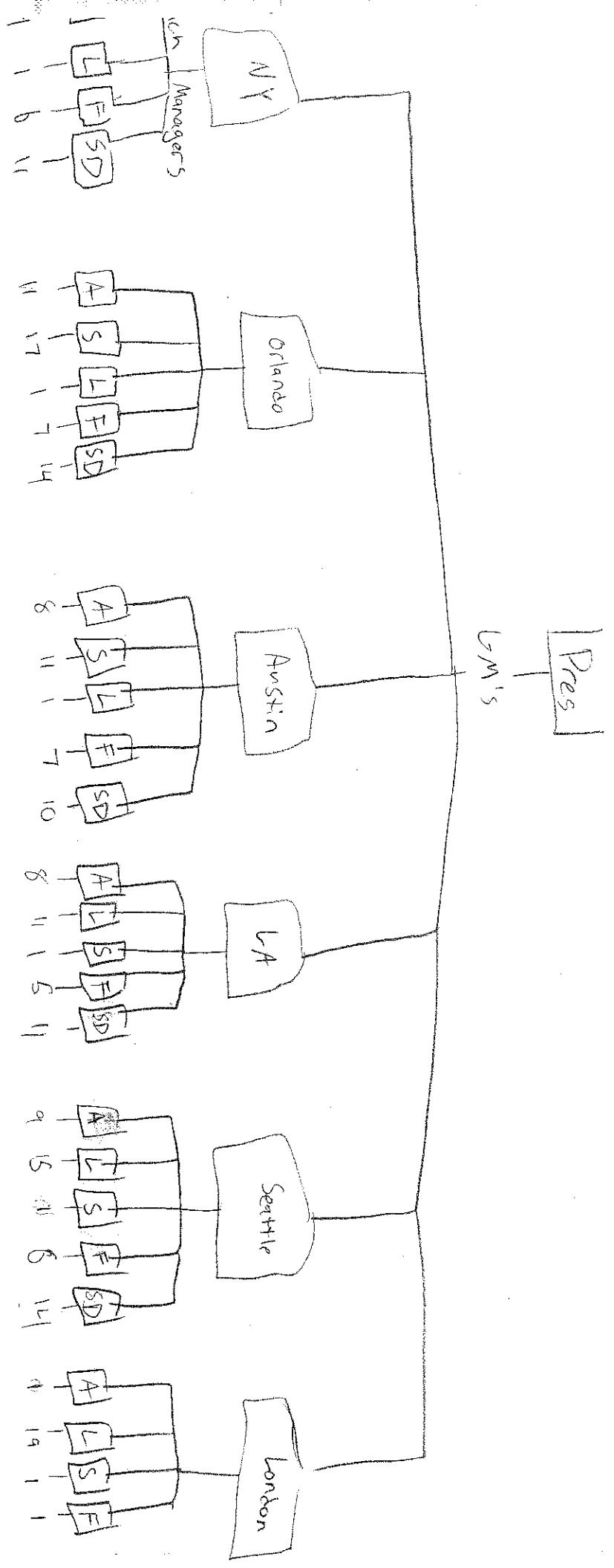

employees

OK, John, Sidney, Andrew, Kelsey

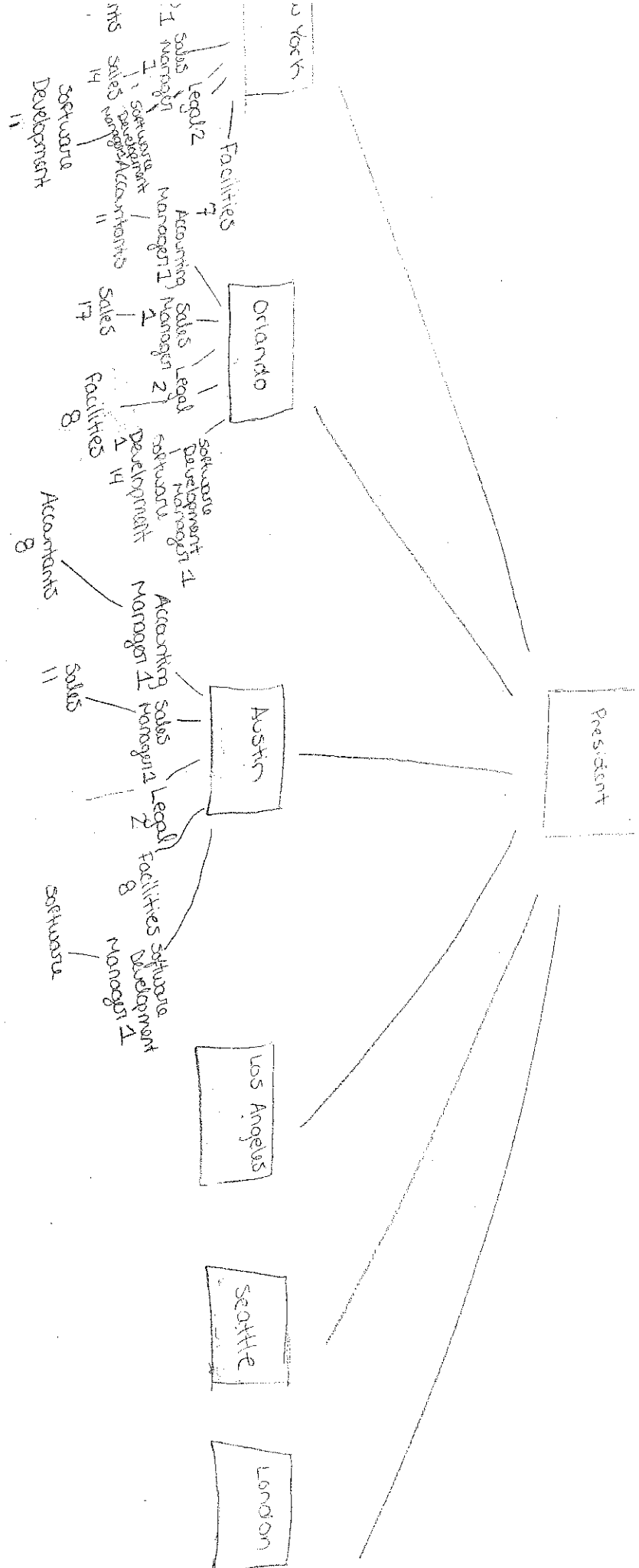

Kunde o Austin  
 Laura o Cristina

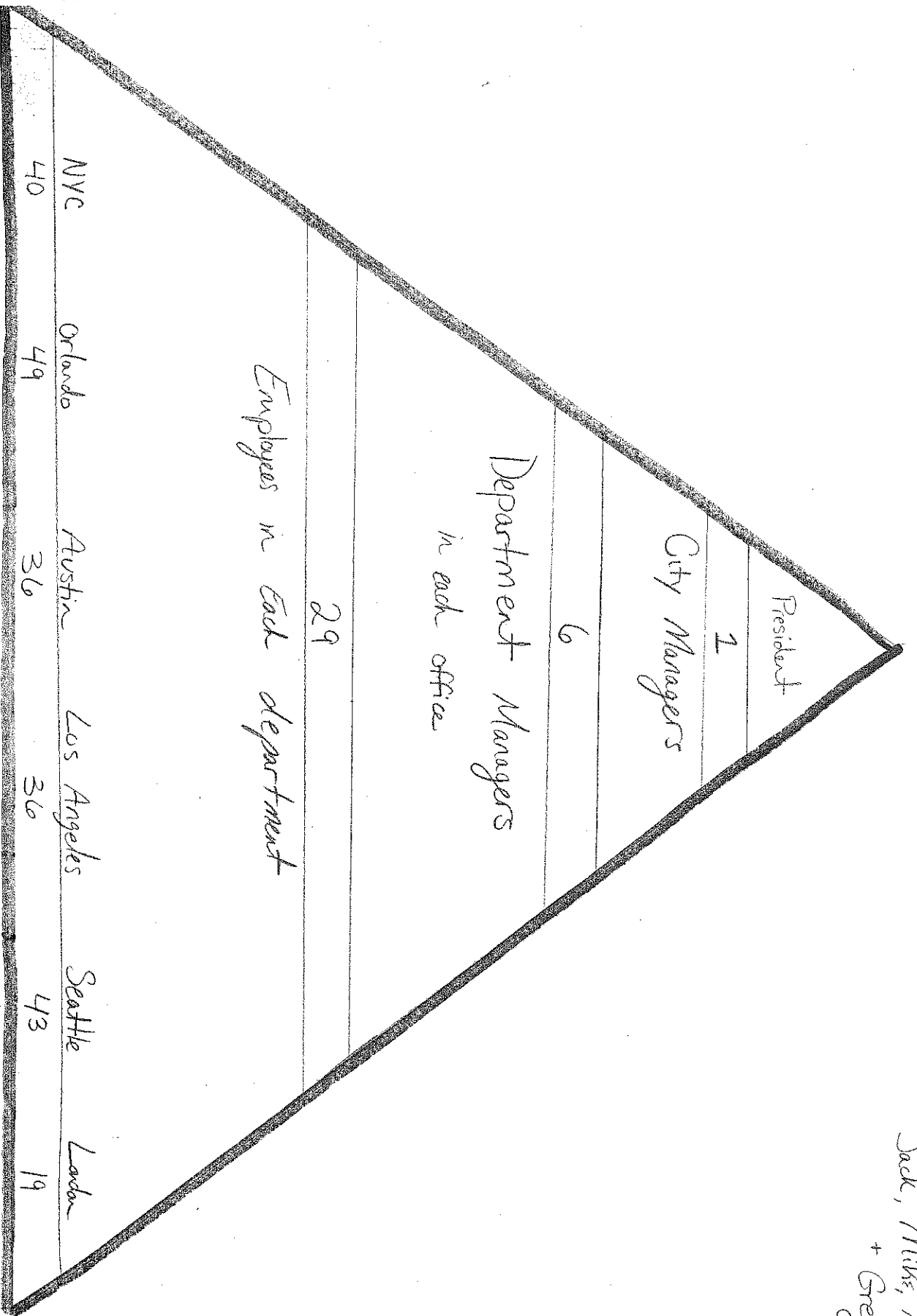

Jack, Mike, Mobbie, Eric  
+ Greg

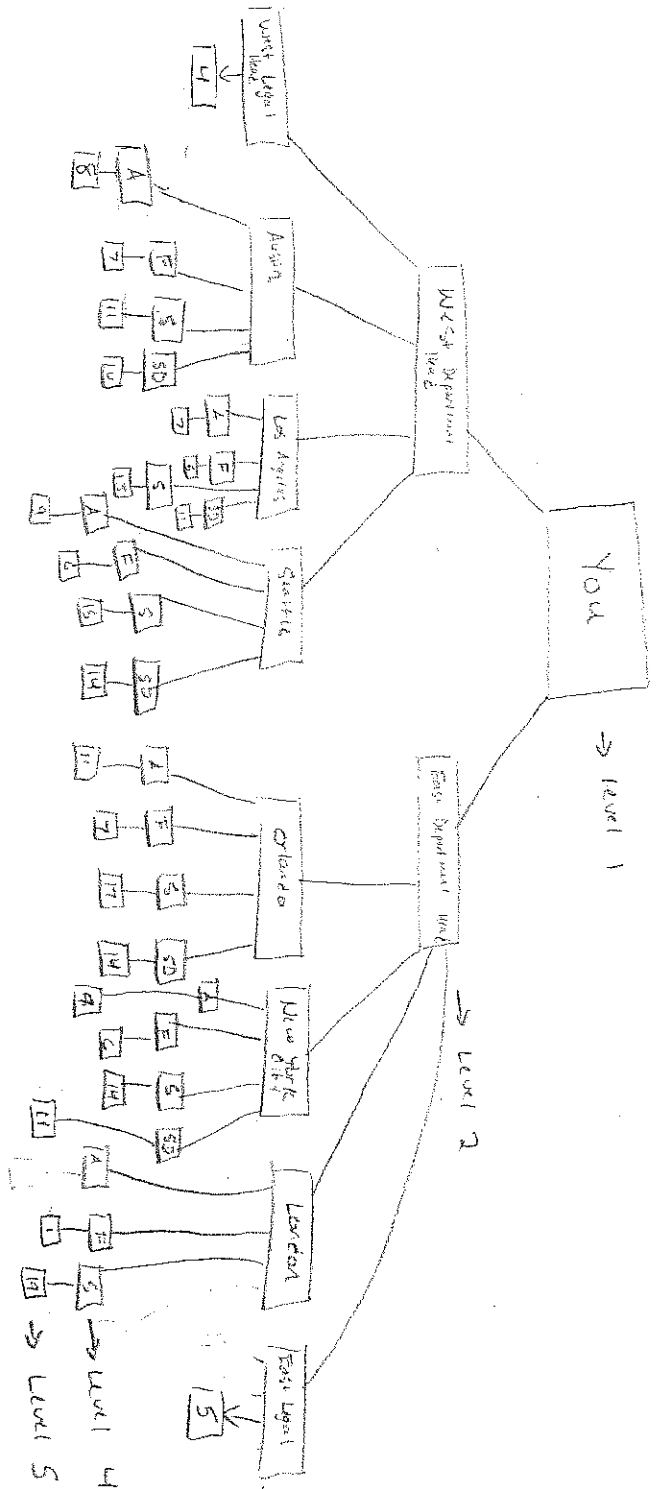

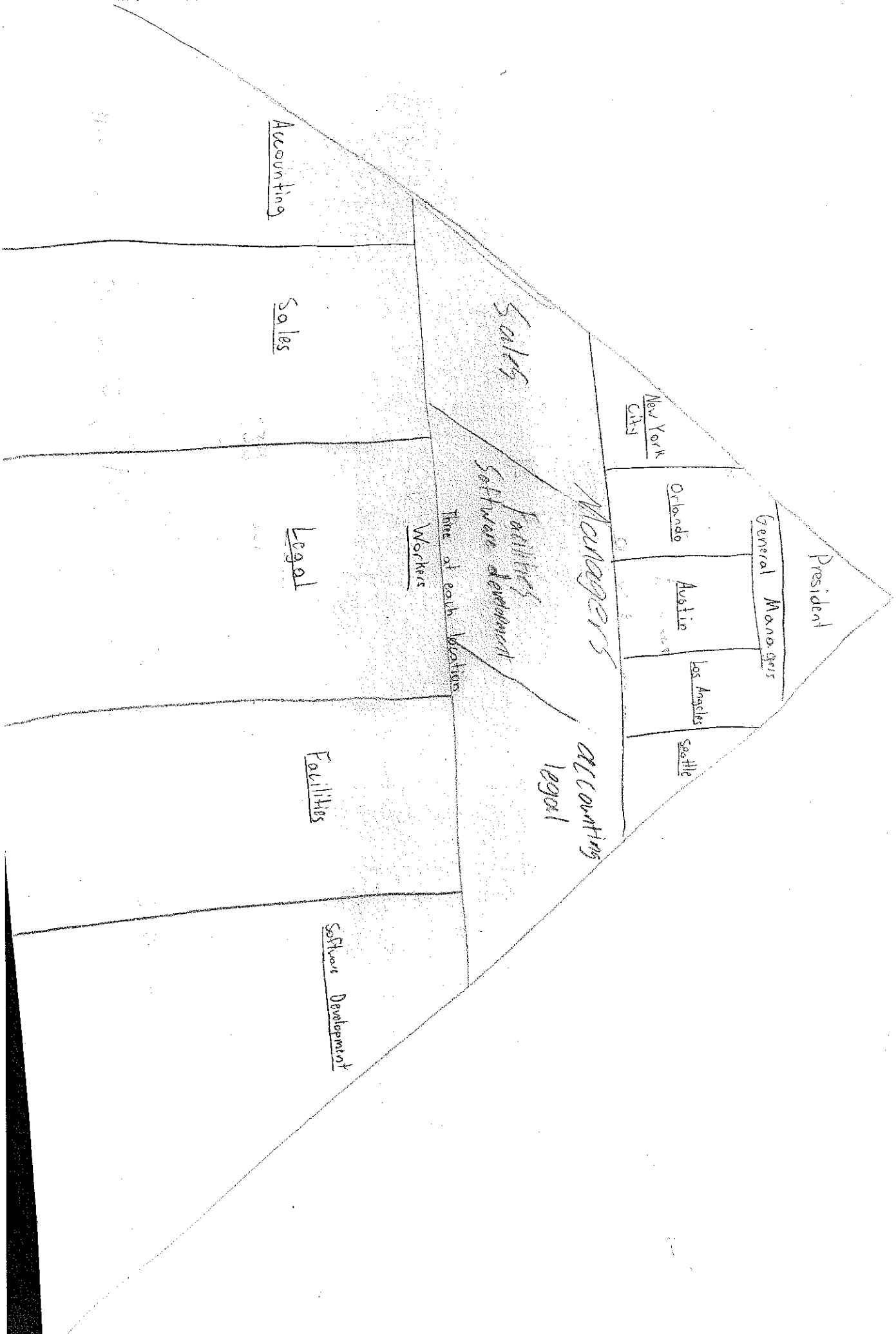

President

General Managers

New York City

Orlando

Austin

Los Angeles

Seattle

Managers

Sales

Facilities  
Software development

Accounting  
legal

Three of each location

Workers

Accounting

Sales

Legal

Facilities

Software Development



10. PETERSON  
 15. BOND  
 11.11. Fitzgerald

NYC	Orlando	AUSHN	Los Angeles	Seattle	London
A: 8	A: 7		A:	A:	A: 9
S: 13	S:		S:	S:	S: 14
L: 1	L:		L:	L:	L: 1
F: 5	F:		F:	F:	F: 5
SD: 10	SD:		SD:	SD:	SD: 7

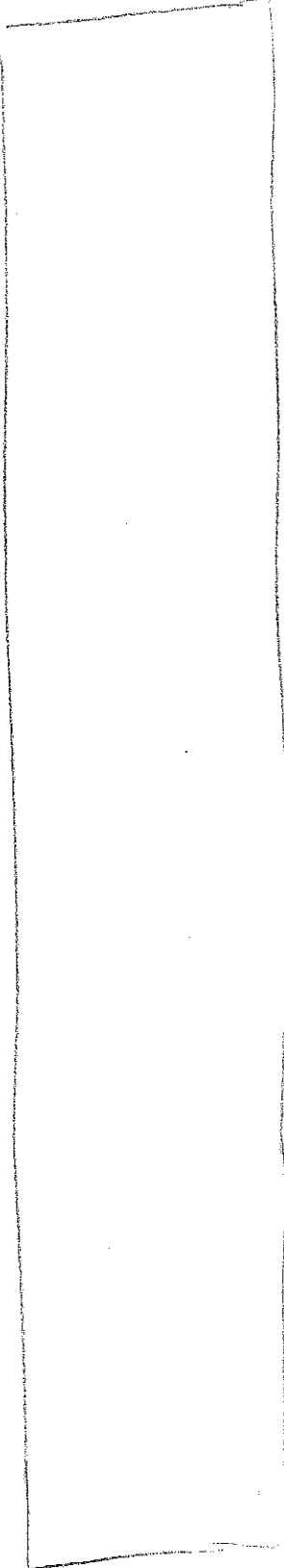
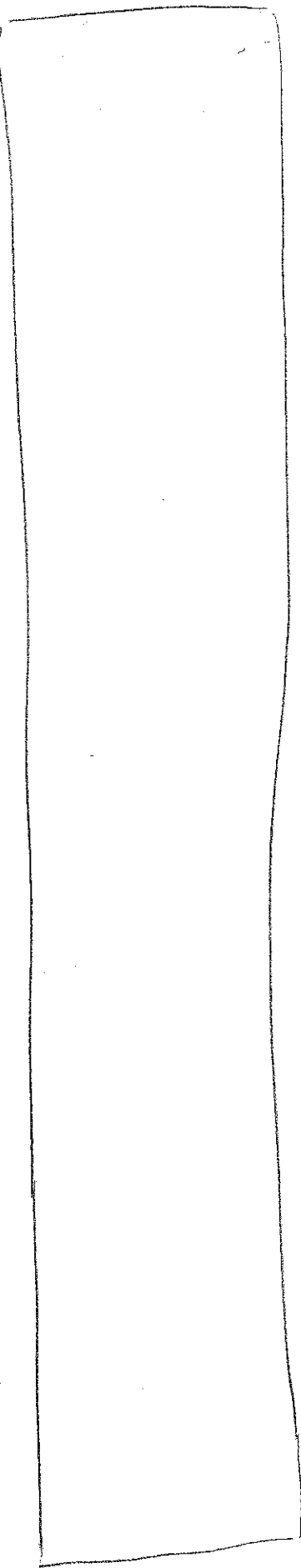

Resident

Head of NYC  
✓  
Asst manager = 9  
S manager = 13  
I manager = 1  
Asst manager = 6  
manpower = 11

Head of Orlando  
AM = 11  
SOM = 16  
LM = 1  
FM = 7  
SDM = 14

Head of Austin  
AM = 8  
SOM = 10  
LM = 1  
FM = 7  
SDM = 10

Head of LA  
AM = 7  
SOM = 12  
LM = 1  
FM = 5  
SDM = 11

Head of Seattle  
AM = 9  
SOM = 14  
LM = 0  
FM = 6  
SDM = 14

Head of London  
AM = 0  
SOM = 18  
LM = 0  
FM = 1